

Article number: 0102090

Description: Retaining ring J85 DIN472
Spring steel

Measures

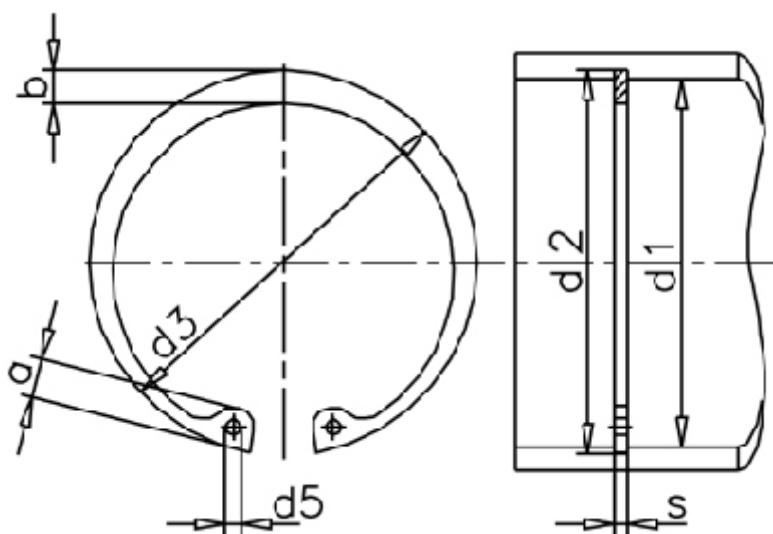

a max	= 8.6	FN kN	= 79.50	t	= 1.75
AN mm ²	= 477.0	FRg kN	= 31.2	tol	= +0,35
b	= 7.2	FR kN	= 201.0	tol	= +1,30-0,54
d1	= 85	g	= 3.0	tol	= -0.08
d2	= 88.5	K kN-mm	= 364.0	Tong	= ZGJ-3
d3	= 90.50	m min	= 3.15	Weight kg/1000	= 25.30
d5 min	= 3.5	Nominal drive	= 5.3		
Description = J 85		s	= 3.00		